

# ZANUSSI

 Electrolux

Washing machine

## ZWF 1850 W

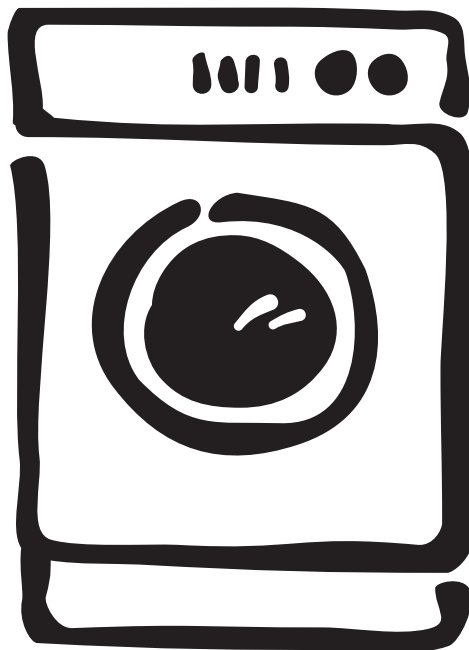

User information

 GB

## Dear Customer,

Please read this user information carefully and keep it to refer to later.

Please pass the user information on to any future owner of the appliance.

### The following symbols are used in the text:



Safety instructions

**Warning!** Information that affects your personal safety.

**Important!** Information that prevents damage to the appliance.



Useful tips and hints



Environmental information

# Contents

<b>Operating Instructions</b> .....	5
<b>Safety</b> .....	5
<b>Disposal</b> .....	6
<b>Description of the appliance</b> .....	7
Control panel .....	7
What is shown in the display .....	7
<b>Programme overview</b> .....	8
<b>Prior to using for the first time.</b> .....	10
Switching on the appliance for the first time - setting the language .....	10
Setting the time. ....	10
<b>Cleaning the machine prior to first use</b> .....	11
<b>Preparing and sorting washing</b> .....	11
<b>Running a wash cycle.</b> .....	11
Opening the door/Loading the washing .....	11
Adding detergent /conditioner .....	12
Switching on the appliance/selecting a programme. ....	13
Changing the temperature .....	13
Changing Spin Speed/Selecting Rinse Hold or Night Cycle .....	13
Setting options .....	14
Extra Rinse, Prewash, Intensive, Quick Iron .....	15
Short/Very Short .....	15
Delay Start .....	16
Starting a programme. ....	16
Programme progress .....	16
Interrupting a programme/Adding washing .....	17
End of the wash cycle/Removing the washing .....	17
<b>Settings</b> .....	18
Memory 1, 2, 3 .....	18
Sound .....	19
Extra Rinse .....	19
Language .....	19
Clock. ....	20
Contrast and Brightness. ....	20
<b>Child safety device</b> .....	21
<b>Cleaning and care</b> .....	22
<b>What to do if...</b> .....	23
Remedying small malfunctions. ....	23
If the wash result is not satisfactory .....	24
Carrying out an emergency drain .....	25
Drain pump .....	26
<b>Technical data</b> .....	27
<b>Consumption values</b> .....	27

<b>Installation and connection instructions</b> .....	28
<b>Safety information concerning installation</b> .....	28
<b>Installing the appliance</b> .....	28
Transporting the appliance .....	28
Removing the transit packaging .....	29
Where to install .....	30
Making the appliance level .....	30
<b>Electrical Connection</b> .....	31
<b>Connecting the appliance to the water supply</b> .....	32
Water inlet .....	33
Water Drainage .....	34
<b>Fitting under kitchen worktops</b> .....	35
<b>Warranty conditions</b> .....	37
<b>Service and Spare Parts</b> .....	39

# Operating Instructions

## Safety

### Prior to using the appliance for the first time

- Follow the “**Installation and connection instructions**”.
- If the appliance is delivered in the winter months when there are minus temperatures: store the washing machine at room temperature for 24 hours before using for the first time.

### Correct use

- The washing machine is only designed for the washing of normal domestic laundry at home.
- Additions or modifications to the washing machine are not permitted.
- Only use detergents/conditioners that are suitable for use in domestic washing machines.
- The washing must not contain any flammable solvent. The risk of explosion exists.
- Do not use the washing machine for dry cleaning.
- Dyes/colour removers may only be used in the washing machine, if the manufacturer of these products expressly permits this. We cannot accept liability for any damage arising.

### Child safety

- Keep packaging away from children. There is a risk of suffocation.
- Children often do not recognise the hazards associated with electrical appliances. Don't allow children to use the washing machine unsupervised.
- Make sure that children and pets don't climb into the drum of the washing machine. The risk of death exists.

### General safety

- Repairs to the washing machine may only be carried out by qualified/authorised service engineers.
- Never use the appliance when the electrical cable is damaged or the control panel, worktop or plinth area are damaged to such an extent that the inside of the appliance is openly accessible.
- Switch off the washing machine prior to cleaning it and carrying out maintenance. In addition, remove the power plug from the power point or – if the appliance has been hard-wired – switch off the cut-out in the fuse box or completely remove the fuse.
- If operation is stopped, disconnect the appliance from the mains supply and turn off the tap.
- Never remove the power plug from the power point by pulling on the cable. Always pull the plug.
- Multiway-plugs, connectors and extension cables must not be used. **Resulting overheating may constitute a fire hazard.**
- Never wash the washing machine down with a water jet. Danger of electric shock.
- When using wash programmes with high temperatures the glass in the door will become hot. Do not touch it!
- Before emergency emptying of the appliance, before cleaning the drain pump or opening the door in an emergency, let the water cool down.
- Small animals can nibble on electrical cables and water hoses. This can constitute a risk of electrocution and water damage. Keep small animals away from the washing machine.

# Disposal



## Packaging material

The packaging materials are environmentally friendly and can be recycled. The plastic components are identified by markings, e.g. >PE<, >PS<, etc. Please dispose of the packaging materials in the appropriate container at your local waste disposal facilities.



## Old appliance

The symbol  on the product or on its packaging indicates that this product may not be treated as household waste. Instead it shall be handed over to the applicable collection point for the recycling of electrical and electronic equipment. By ensuring this product is disposed of correctly, you will help prevent potential negative consequences for the environment and human health, which could otherwise be caused by inappropriate waste handling of this product. For more detailed information about recycling of this product, please contact your local city office, your household waste disposal service or the shop where you purchased the product.



**Warning:** When your appliance has finished its working life, remove the plug from the mains socket. Cut off the cable and plug and dispose of them.

Destroy the door lock. This prevents children from trapping themselves inside and endangering their lives.

# Description of the appliance

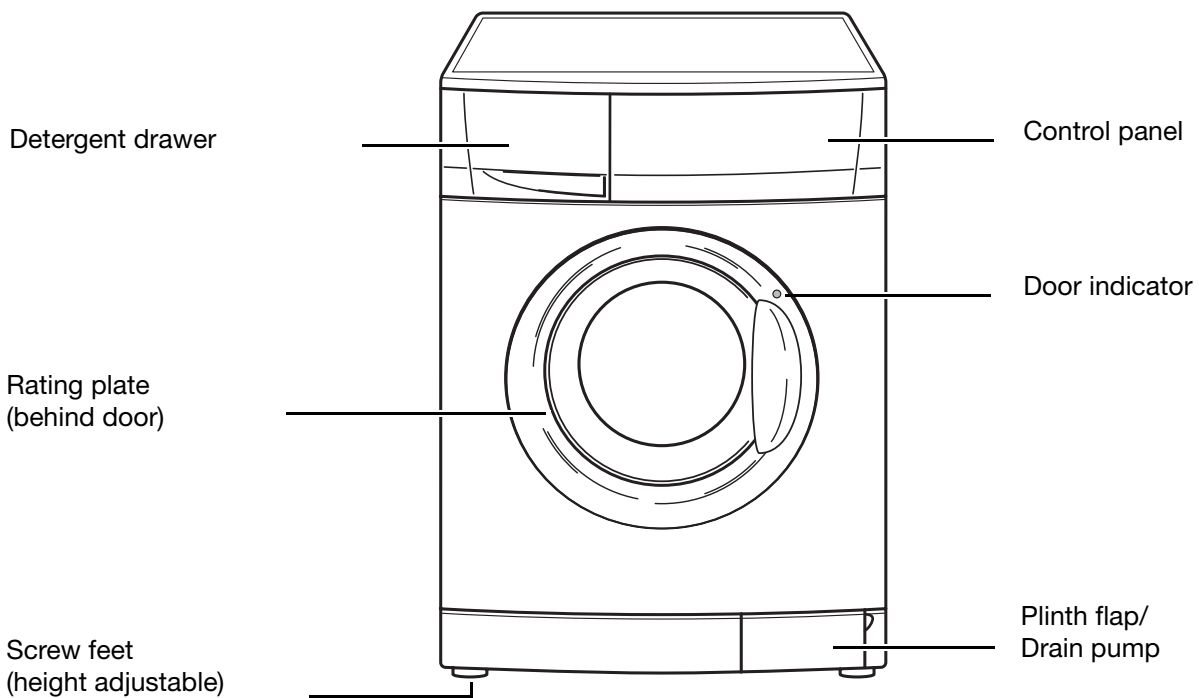

## Control panel

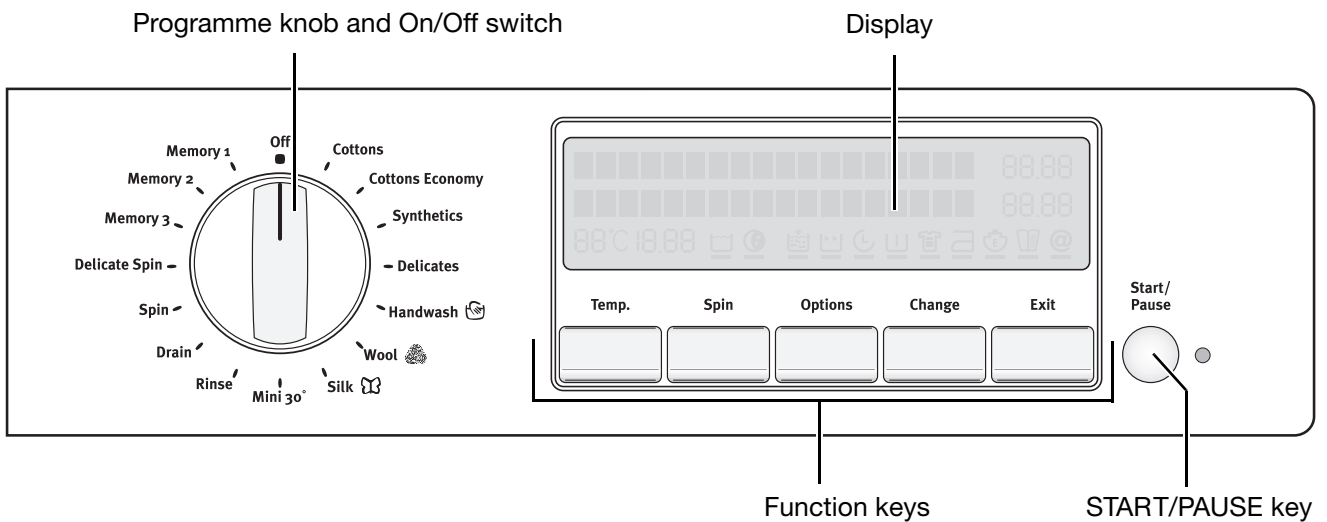

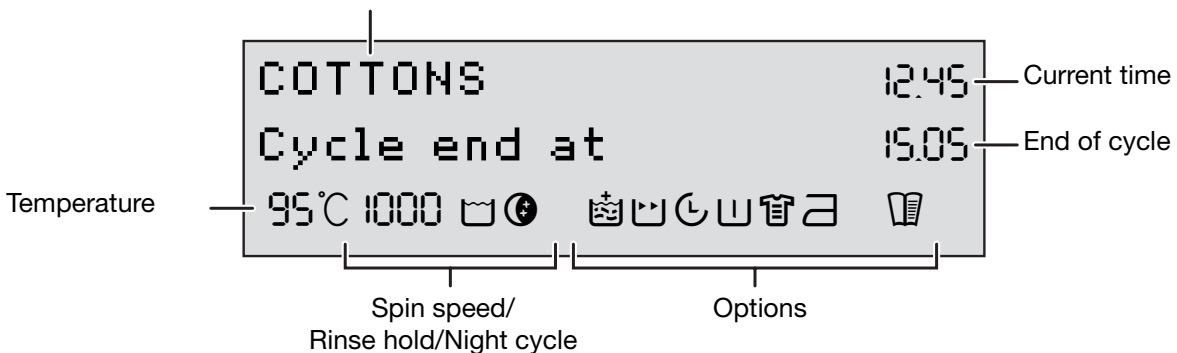

## What is shown in the display

Information field, shows the current settings















# Programme overview

Programme	max. Load <sup>1)</sup> (dry washing)	Options							Spin speed				RINSE HOLD	NIGHT CYCLE	
		EXTRA RINSE	SHORT	VERY SHORT	DELAY START	PREWASH	INTENSIVE	EASY IRON	1800/1600/1400/1200/ 1000	900	700/500	0			
COTTONS 95°, 60°, 50°, 40°, 30°, Cold	5kg	•	•	•	•	•	•	•	•	•	•	•	•	•	•
COTTONS ECONOMY 60° <sup>2)</sup> , 50°, 40°	5kg	•			•	•		•	•	•	•	•	•	•	•
SYNTHETICS 60°, 50°, 40°, 30°, Cold	2,5kg	•	•	•	•	•	•	•		•	•	•	•	•	•
DELICATES 40°, 30°, Cold	2,5kg	•		•	•	•					•	•	•	•	•
HANDWASH  40°, 30°, Kalt	2kg				•					•	•	•	•	•	•
WOOL  40°, 30°, Cold	2kg				•					•	•	•	•	•	•
SILK 	1kg	•			•						•	•	•	•	•
MINI 30°	2,5kg				•						•	•	•	•	•
RINSE	5kg	•			•			•	•	•	•	•	•	•	•
DRAIN	-														
SPIN	5kg								•	•	•				
DELICATE SPIN	2,5kg										•				

1) A 10 litre bucket contains approximately 2.5 kg of dry washing (cotton).

2) Programme settings for tests in accordance with or support of EN 60 456 and IEC 60 456 are described in the section “Consumption values”.



Application/features:	Care symbols <sup>1)</sup>
Programme for normally to heavily soiled whites and coloureds made of cotton/linen.	
Energy-saving programme for lightly to normally soiled whites/coloureds made of cotton/linen.	
Programme for easy-care mixed fibres and synthetics.	
Gentle programme for delicate fabrics such as bonded fabrics, microfibres, synthetics, net curtains. (max. load for net curtains 15 to 20 m <sup>2</sup> ). With RINSE HOLD also suitable for fabrics with climate membrane, e. g., outdoor clothing.	
Particularly gently programme for fabrics that are normally washed by hand.	
Particularly delicate programme for machine washable and hand washable wool or wool mixtures.	
Particularly delicate programme at 30 °C, for machine washable and hand washable silk. Wash very delicate items individually.	
Special programme at 30 °C, approx. 30 minutes long, for quickly washing through items such as e. g. once worn, slightly dirty sports clothing or new clothes.	
Separate rinse (3 rinses, liquid conditioner is washed in from compartment  , spin).	
Drains water away after a RINSE HOLD or after the NIGHT CYCLE.	
Drains water out and spins, e. g. after a RINSE HOLD/NIGHT CYCLE, or separate spin for hand-washed cottons/linens and easy-cares.	
Drain and delicate spin after a rinse hold, or separate delicate spin of handwashed delicates, woollens, silk.	

1) The numbers in the care symbols show the maximum temperatures.

# Prior to using for the first time

## Switching on the appliance for the first time - setting the language

The display is set to English as standard in the factory.

**i Important!** If the display does not show the menu for setting the language when the appliance is switched on, the appliance has been switched on before. If this happens, please see the section “Settings/Language”.

To switch on the appliance, turn the programme knob to any programme, e. g. COTTONS.

The display lights up and should look like the illustration opposite.

In addition the display alternately shows:

- “To confirm push OK key”
- “To change push OPTION key”

### If you want to change the language:

1. Press the CHANGE key repeatedly, until the desired language appears in the display, e. g. DEUTSCH.
2. Press the EXIT key.

In the display DEUTSCH flashes several times and the display should then look like e. g. the illustration opposite.

3. To switch the appliance off, turn the programme knob to OFF.

### If you want to keep the language:

Press the EXIT key.

## Setting the time

So that the time and the end of the programme are correctly displayed, please check the time shown in the display and set the current time if necessary. To do this, please see the section “Settings/Clock”.



# Cleaning the machine prior to first use

In order to remove any residues from the drum and water container which may have been left during manufacturing, perform the first wash cycle without any washing in the machine. Programme: COTTONS 60 °C, option VERY SHORT, add approx. 1/4 measuring cup of detergent.

## Preparing and sorting washing

### Preparing washing

- Empty the pockets. Remove foreign bodies (e.g. coins, paper clips, nails, etc.).
- Do up zips, button up covers to prevent damage to washing.
- Remove the runners from net curtains or cover them with a net or a bag.
- Wash delicate and small items in a net/pillowcase, e. g. net curtains, tights, small socks, handkerchiefs, bras.

**Important:** Bras and other items containing wires should only be washed in a net bag. The wires can work loose and damage the appliance.

### Sorting washing

- By colour: Wash white and coloured washing separately. Washing can run.
- By temperature, type of washing and care symbol.

**Important:** Do not wash fabrics with the  care symbol (= do not wash!) in the washing machine.

## Running a wash cycle

### Opening the door/Loading the washing

1. To open the door: pull the handle on the door.
2. Unfold washing and load it loosely into the machine. Mix large and small items.  
**Attention!** Do not get any washing caught between the door and the rubber seal.
3. Push the door firmly shut. Door catch must audibly click shut.

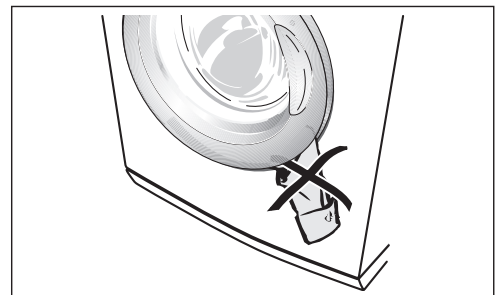

# Adding detergent / conditioner

**Important:** Only use detergents/conditioners that are suitable for use in household washing machines.

Add detergent/conditioner in accordance with the detergent/conditioner manufacturer's instructions. Observe instructions on the packaging.

The amount of detergent used depends on:

- the degree of soiling,
- the load size
- the hardness of the tap water.
- If the manufacturer does not make any recommendations with regard to small volumes of washing: For a half-load use a third less, and for a very small load use only the half the amount of detergent that is recommended for a full load.
- Water softener should be used from water hardness range 2 (=medium). The amount of detergent used can then always be that as for hardness range 1 (=soft). Your local water company will provide you with information about water hardness in your area.

1. Pull out the detergent drawer as far as it will go.
2. Add the detergent/conditioner.
3. Push the detergent drawer in fully.

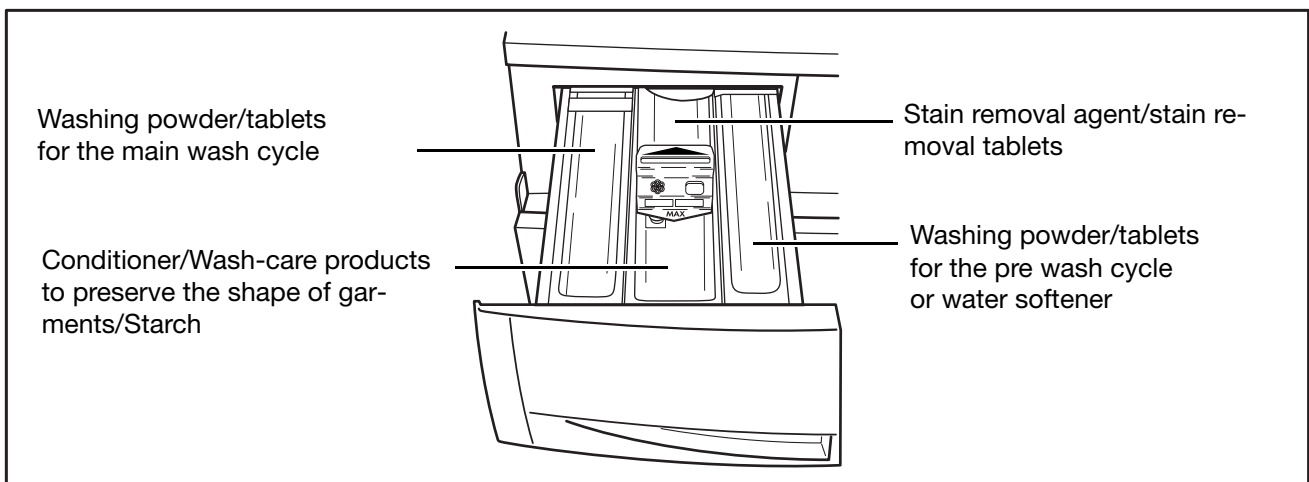

## Washing powder/tablets for the main wash cycle

If you are using water softener and require the right compartment for detergent for the pre-wash cycle, add the water softener on top of the detergent for the main wash cycle in the left compartment.

## Softener, wash-care products to preserve the shape of garments, starch

Fill the compartment to no more than the MAX indicator. Add water to thick liquid concentrates in accordance with the manufacturer's instructions before using them. Dissolve powder starch.

## If you are using liquid detergent:

Add liquid detergent using measuring containers provided by the detergent manufacturer.

## Switching on the appliance/selecting a programme

Select the programme using the programme knob.

**i** When you select a programme, you switch the appliance on at the same time.

- The display lights up and shows the programme set, the current time and the estimated end of the cycle.
- Depending on the programme, the washing machine suggests a temperature and a spin speed. You can change these suggestions.

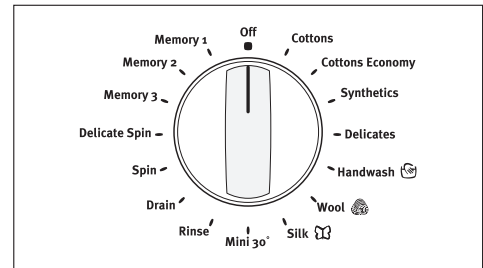



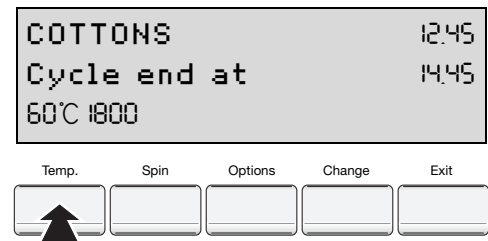

## Changing the temperature

Press the TEMP. key repeatedly until the desired temperature is displayed.



## Changing Spin Speed/ Selecting Rinse Hold or Night Cycle

Press the SPIN key repeatedly, until the desired spin speed or  RINSE HOLD or  NIGHT CYCLE is displayed:

- With spin speed "0" the last rinse water is drained off at the end of the cycle, but the washing is not spun.
- With  RINSE HOLD the washing is left to soak in the last rinse water. There is no final spin after the intermediate spin(s). Intermediate spins are programme-dependent and cannot be altered.
- With  NIGHT CYCLE the washing is left to soak in the final rinse water. There is no final spin and no intermediate spin. Because of this the programme runs very quietly.  NIGHT CYCLE is therefore particularly suitable if you want to wash at night.

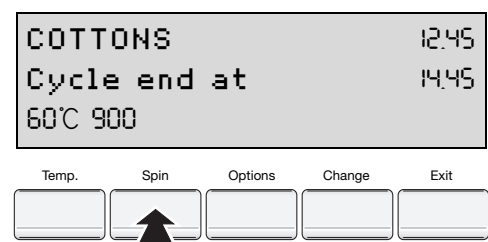

# Setting options

Options can be added to a wash cycle that has already been selected.

Press the OPTIONS key. The display shows the symbols for the options.

## **EXTRA RINSE**

Depending on the cycle, the appliance carries out one or more additional rinses. EXTRA RINSE can also be permanently set (see section "Settings").

## **SHORT/VERY SHORT**

Shortened wash cycle for lightly soiled washing.

- SHORT: for COTTONS and SYNTHETICS
- VERY SHORT: for COTTONS, SYNTHETICS and DELICATES.

## **DELAY START**

To delay the start of a programme by between 30 minutes and a max. of 20 hours.

## **PREWASH**

Pre-washes at about 30 °C before the main wash cycle, which follows automatically.

## **INTENSIVE**

For heavily soiled or stained washing. In-wash stain treatment products are washed in at the beginning of the programme.

## **EASY IRON**

There is no intermediate spin and the final spin is shortened, to prevent creasing to a great extent. Suitable for fabrics which, after this programme, need no or very little ironing.

## **SETUP**

Setup are options that remain permanently stored in the appliance, e. g., time, language, etc. (see section "Settings"), until they are changed or deactivated.

 Only the options that can be combined with the cycle that has already been set are shown in the display.

## Extra Rinse, Prewash, Intensive, Quick Iron

1. Press the OPTIONS key repeatedly until the desired symbol flashes, e. g.,  EXTRA RINSE. (With each press of the key, the next symbol flashes – moving from left to right.)

2. Press the CHANGE key. A black bar appears under the symbol. The display changes from NO to YES. The option is set. To switch the option off, press the CHANGE key again.

 If other options are to be selected: Press the OPTIONS key repeatedly until the desired symbol flashes and confirm each one with the CHANGE key.

3. Press the EXIT key, to return to the exit icon. The display shows the symbol for the selected option.

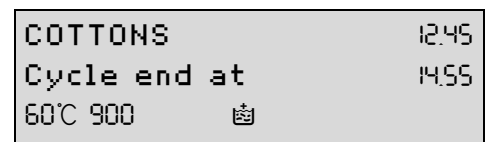
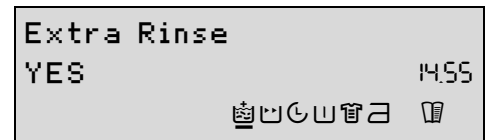
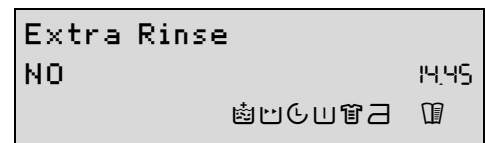

## Short/Very Short

1. Press the OPTIONS key repeatedly, until the SHORT symbol  flashes.



2. Press the CHANGE key once. A black bar appears under the  symbol, SHORT (or VERY SHORT in the case of DELICATES) appears in the display.

3. To change from SHORT to VERY SHORT, press the CHANGE key again.

4. Press the EXIT key. The display shows the SHORT symbol  as well as the time for the end of the cycle.



## Delay Start

1. Press the OPTIONS key repeatedly, until the DELAY START symbol  flashes.
2. Press the CHANGE key. A black bar appears under the DELAY START symbol , "Start in 30 min" is shown in the display. Press the CHANGE key repeatedly, until the display shows the desired period by which you want to delay the start, e. g. "Start in 4 h" (=4 hours).

**i** If 20 h is displayed and you press the key again, the delayed start is cancelled.

3. Press the EXIT key. The display shows the DELAY START symbol  and the time until the end of the programme (including period by which the start has been delayed).
4. To activate the Delay Start, press the START/PAUSE key. The display now shows e.g. "Start in 4h" (=4 hours). The time remaining to the start of the wash cycle is continuously displayed (e. g., 4.00, 3.30, 3.00, ... 0.30 etc.).



## Starting a programme

1. Check that the water tap is open.
  2. Press the START/PAUSE key.
- The programme is started or it starts after the time delay set has elapsed.

**i** If after pressing the START/PAUSE key the display shows "Door not Closed", the door has not been shut properly. Push the door firmly closed and press the START/PAUSE key again.

## Programme progress

The display indicates the stage of the programme that is currently being performed as well as the time to the end of the programme.

**i** During the wash cycle the time to the end of the programme may change as the programme adjusts itself to different conditions (e. g., type and quantity of laundry, out of balance spin detection, special rinses, etc.).

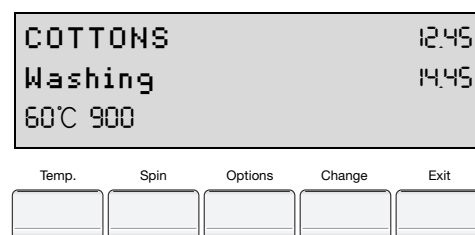



# Interrupting a programme/ Adding washing

## Interrupting a programme

- The programme can be interrupted at any time by pressing the START/PAUSE key. It is then re-started by pressing the key again.
- To stop the washing machine before the programme has ended, turn the programme knob to OFF.  
**Important!** Be careful if there is water in the appliance!

## Adding washing

1. Press the START/PAUSE key.
- If “Door locked” and “Pause” are alternately shown in the display, it is no longer possible to add washing, e. g. when the water level is too high.
  - If “Door openable” and “Pause” are alternately shown in the display, it is still possible to add washing:
2. Open the door.
  3. Add washing and close the door again.
  4. Press the START/PAUSE key again. Programme will continue.

# End of the wash cycle/ Removing the washing

At the end of the programme, “Cycle ended” and “Door openable” are alternately shown in the display.

1. Open the door and remove the washing.
2. Turn the programme knob to OFF.
3. Turn off the tap.
4. When you have finished washing, pull out the detergent drawer a little to let it to dry out. Keep the door very slightly open so that the washing machine can air.

## If RINSE HOLD or NIGHT CYCLE was selected:

After a RINSE HOLD or when a programme with NIGHT CYCLE has ended, the START/PAUSE indicator flashes. “Cycle ended” and “Door locked” appear alternately in the display.

The water must first be drained off:

- Turn the programme knob to OFF, then to DRAIN and press the START/PAUSE key (the water is drained without spinning),  
or
- turn the programme knob to OFF and then to SPIN. Change the spin speed if necessary and press the START/PAUSE key (the water is drained and the washing spun).

# Settings



Settings are special functions that remain permanently stored independent of each washing cycle – even after the appliance has been switched off.

## Memory 1, 2, 3

Programme combinations can be stored at programme knob positions MEMORY 1, 2, 3 and can then be selected using the programme knob. To do this the desired programme combination is first put together and then stored.

### Setting the Memory

Example: Programme position MEMORY 1 is to be given the following programme combination: SYNTHETICS 60 °C, 700 rpm, with PREWASH.

1. Turn the programme knob to SYNTHETICS.
2. Press the TEMP. key repeatedly, until 60 °C appears in the display.
3. Press the SPIN key repeatedly, until 700 appears in the display.
4. Using the OPTIONS key set  PREWASH and press the CHANGE key.  
A black bar appears under the PREWASH symbol .
5. Press the OPTIONS key repeatedly, until the SETUP symbol  flashes.
6. Press the CHANGE key. The display changes to the Settings Options level. Programme memory position MEMORY 1 is offered as the first option.

 To change to another memory position, press the OPTIONS key.

7. Press the CHANGE key.

The programme combination is now stored to programme knob position MEMORY 1 and in the future can be selected directly using the programme knob.

### Changing the Memory

1. Put together the new programme combination as required (for an example, see “Setting the Memory”, steps 1 to 4).
2. Press the OPTIONS key repeatedly, until the SETUP symbol  flashes.
3. Press the CHANGE key.
4. Using the OPTIONS key select the memory position to be changed, e. g. MEMORY 1.
5. Store the new programme combination using the CHANGE key.

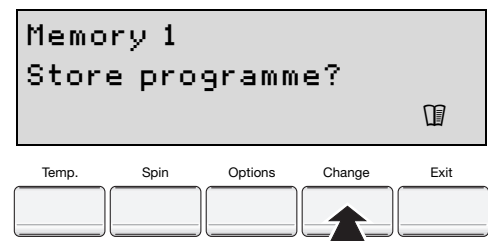

## Sound

The volume of the acoustic signal can be selected.

1. Turn the programme knob to any programme and press the OPTIONS key repeatedly until the SETUP symbol  flashes.
2. Press the CHANGE key.
3. Press the OPTIONS key repeatedly, until SOUND is shown in the display.
4. Press the CHANGE key repeatedly until the desired volume (NORMAL, LOW, NO SOUND) is shown in the display.
5. Press the EXIT key twice.

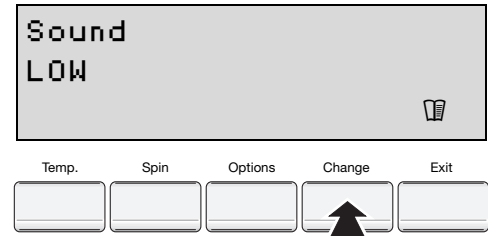

## Extra Rinse

1. Turn the programme knob to any programme and press the OPTIONS key repeatedly until the SETUP symbol  flashes.
2. Press the CHANGE key.
3. Press the OPTIONS key repeatedly until EXTRA RINSE is shown in the display.
4. Press the CHANGE key. The display changes from NO to YES (to switch off, press the CHANGE key again).
5. Press the EXIT key twice.

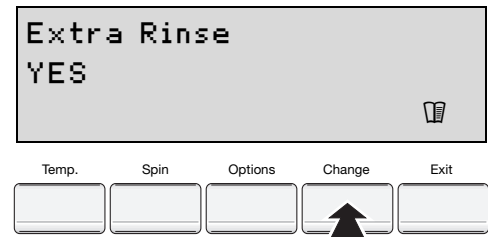

## Language

1. Turn the programme knob to any programme and press the OPTIONS key repeatedly until the SETUP symbol  flashes.
2. Press the CHANGE key.
3. Press the OPTIONS key repeatedly, until LANGUAGE is shown in the display.
4. Press the CHANGE key repeatedly, until the desired language appears in the display, e.g. DEUTSCH.
5. Press the EXIT key twice.

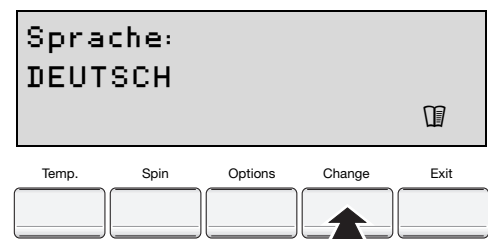

## Clock

1. Turn the programme knob to any programme and press the OPTIONS key repeatedly until the SETUP symbol  flashes.
2. Press the CHANGE key.
3. Press the OPTIONS key repeatedly, until CLOCK is shown in the display.
4. Using the CHANGE key set the desired time. With each press of the key, the display moves on by one minute. If the key is kept pressed, the display changes in 10 minute steps.
5. Press the EXIT key twice.

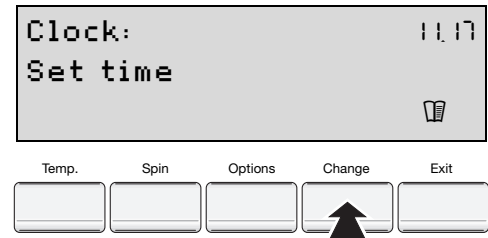

## Contrast and Brightness

1. Turn the programme knob to any programme and press the OPTIONS key repeatedly until the SETUP symbol  flashes.
2. Press the CHANGE key.
3. Press the OPTIONS key repeatedly, until the display shows CONTRAST or BRIGHTNESS.
4. Press the CHANGE key. With each press of the key or if the key is kept pressed down, the black triangle in the diagram moves further to the right for more contrast or brightness. If the triangle reaches the right hand edge, it starts again from the left.
5. Press the EXIT key twice.

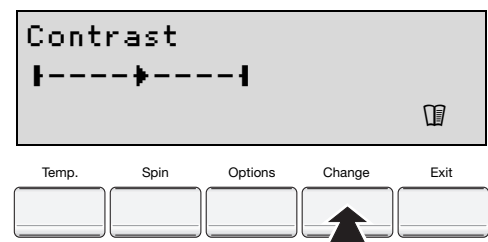

# Child safety device

If the child safety device has been activated, the door can no longer be shut.

## Activating the child safety device:

Use a coin to turn the knob (on the inside of the door) in a clockwise direction as far as it will go.

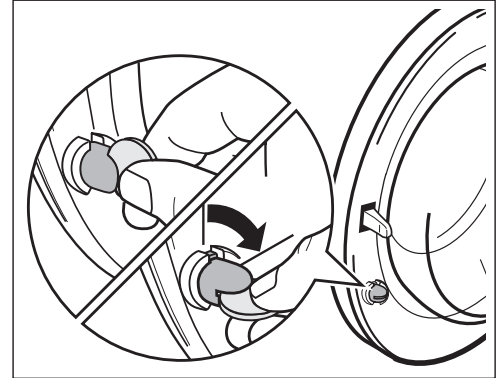

**Warning!** The knob must not be depressed after being set, otherwise the child safety device is not activated. The knob must stand proud as shown in the illustration.

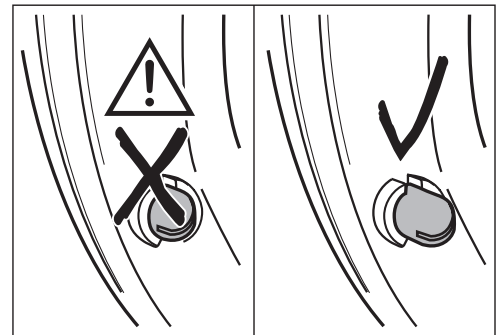

## Deactivating the child safety device:

Turn the knob in an anti-clockwise direction as far as it will go.

# Cleaning and care

**Important:** Do not use furniture cleaning products or aggressive cleaning agents to clean the appliance. Wipe over the control panel and housing with a damp cloth.

## Detergent drawer

The detergent drawer should be clean regularly.

1. Remove the detergent drawer by pulling firmly.
2. Remove the softener insert from the middle compartment.
3. Clean all parts with water.
4. Place the softener insert in as far as it will go, so that it is firmly in position.

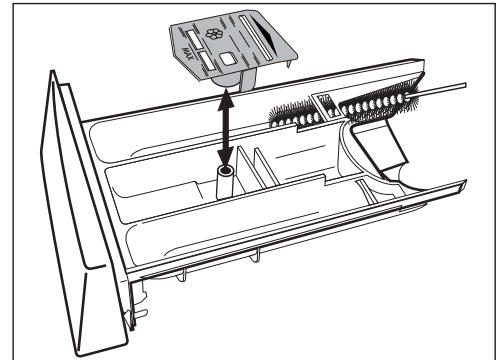

5. Clean the entire drawer recess area of the washing machine, in particular the jets on the upper side of the washing-in chamber, with a brush.
6. Place the detergent drawer in its guide rails and push it in.

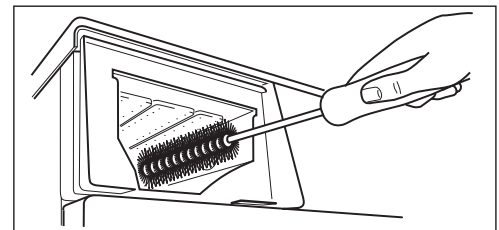

## Washing drum

Rust deposits in the drum may occur due to rusting foreign bodies in the washing or tap water containing iron.

**Important!** Do not clean the drum with acidic descaling agents, scouring agents containing chlorine or iron or steel wool.

1. Remove any rust which has accumulated in the drum using a cleaning agent for stainless steel.
2. Run a washing cycle without any washing to clean off any cleaning agent residues. Programme: COTTONS 60°, option VERY SHORT, add approx. 1/4 of a measuring cup of washing powder.

## Door and rubber collar

Regularly check whether deposits or foreign substances are present in the folds of the rubber collar or inside on the door glass.

Regularly clean the door glass and the rubber collar.

# What to do if...

## Remedying small malfunctions

If one of the following messages is displayed in the display during operation:

- "No incoming water/Check tap & Hose",
- "No drain - check drain hose/filter" or "Pump Blocked",
- "Door not Closed",

please have a look at the following table.

When the fault is remedied, press the START/PAUSE key.

If "Warning : E and number or letter" is displayed: Switch the appliance off and on again. Re-set the programme. Press the START/PAUSE key. If the warning is displayed again, please contact your local Service Force Centre and inform them of the warning.

Problem	Possible cause	Remedy
Washing machine is not working.	Mains plug not plugged in or fuse not working.	Connect the plug to a mains socket. Check fuse.
	Door not closed properly.	Close door - there should be an audible click.
	The START/PAUSE key was not pressed for long enough.	Press the START/PAUSE key for longer.
The door cannot be closed.	Child safety device engaged.	Release the child safety device.
Display shows: "Selection error".	The selected function cannot be combined with other programme settings.	Select another function.
Display shows: "Door not Closed".	Door not closed properly.	Close door - there should be an audible click. Restart the programme.
Display shows: "No incoming water/Check tap & Hose"	Tap turned off.	Turn on the tap.
	The filter in the threaded inlet hose fitting is blocked.	Turn off the tap. Unscrew the hose, take out the filter and clean it.
	Water tap is furred with lime scale or is faulty.	Check the tap and have it repaired, if necessary.
The washing machine vibrates when operating or is not stable.	Transit bar has not been removed.	Remove the transit bar.
	The screw feet not correctly adjusted.	Adjust feet according to the Installation and Connection instructions.
	There is very little washing in the drum (e. g., just one bathrobe).	Operation is not affected by this.
Water is running out from under the washing machine.	Screw connection on the inlet hose is leaking.	Screw the inlet hose in firmly.
	Drain hose is leaking.	Replace drain hose.
	Drain pump cover is not closed properly.	Close the cover properly.
	Washing was caught in the door.	Load washing carefully for the next wash.
	Emergency drain hose is leaking.	Close off emergency drain hose properly.

Problem	Possible cause	Remedy
Display shows: "Excess Detergent"	Probably too much detergent has been used.	Follow the manufacturer's instructions exactly when measuring out detergent.
Display shows: – "No drain - check drain hose/filter" or – "Pump Blocked".	Kink in drain hose.	Straighten the hose.
	Maximum pumping height of 1 m exceeded.	Refer to installation instructions and make any necessary adjustments.
	Drain pump is blocked.	Switch off the appliance. Disconnect the power plug. Clean the drain pump. Remove foreign bodies from the pump housing.
	For sink spigot connections: Sink outlet is blocked.	Clean the sink spigot.
Fabric softener not rinsed in,  compartment for additives is filled with water.	Conditioner insert in the compartment for additives is not correctly attached or is blocked.	Clean the detergent drawer, insert the conditioner insert firmly.
The door cannot be opened when the washing machine is switched on.	Door locked.	Wait until the display alternately shows "Door openable" and "Cycle ended".
	There has been a power cut. (All indicators are off.) For safety reasons, the door will remain locked for between 4 and 10 minutes.	The programme will continue when the power cut is over.  To remove washing: If water can be seen in the appliance, before opening the door, first perform an emergency drain.
Washing is heavily creased.	Possibly too much washing was loaded.	Observe maximum loads.

## If the wash result is not satisfactory

### The washing is grey and there are lime-scale deposits in the drum

- Too little detergent was used.
- An incorrect detergent was used.
- Individual stains were not pre-treated.
- The programme or temperature was not set properly.

### There are grey stains on the washing

- Items that were soiled with ointments, fats or oils were washed using too little detergent.
- The wash temperature used was too low.
- A common cause is that conditioner – in particular the type in concentrated form - has come in contact with the washing. Wash out such marks as soon as possible and exercise care when using the said conditioner.

### Foam can still be seen following the final rinse

- Modern detergents can cause foam to be created even during the final rinse. In spite of this, the washing has been sufficiently rinsed.

### There are white residues on the washing

- What can be seen here are insoluble substances which modern detergents contain. They are not the result of insufficient rinsing. Shake or brush the washing. If possible turn the washing inside out before washing. Check your choice of detergent. Especially with dark colours it is advisable to use liquid detergents.



# Carrying out an emergency drain



**Warning!** Prior to carrying out an emergency drain, switch off the washing machine and remove the power plug from the power point.

**Warning!** The water that comes out of the emergency drain hose may be hot. There is a risk of scalding. Let the water cool before performing an emergency drain!

1. Open the plinth flap and remove it.

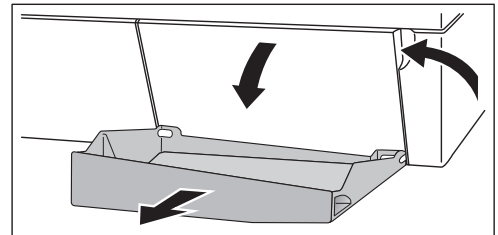

2. Remove the emergency drain hose.

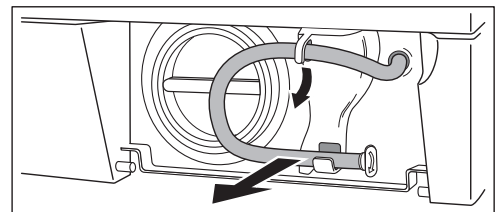

3. Place a shallow container underneath it. Then loosen the drain plug by turning it in an anti-clockwise direction and pull it out.

4. The water will run out. If it is necessary to empty the container more than once, seal up the emergency drain hose with the drain plug while you are doing so.

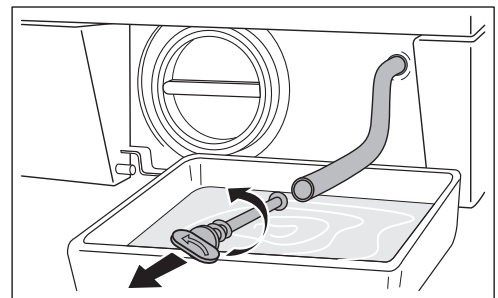

## When the water has all drained away:

5. Insert the plug firmly into the emergency drain hose and turn it in a clockwise direction until it is firmly in place.

6. Replace the emergency drain hose into the retainer.

7. Insert the plinth flap into place and close it.

# Drain pump

The drain pump is maintenance-free. It is only necessary to open the pump cover if there is a malfunction and water is no longer being pumped out, e.g. if the pump wheel is blocked.

Before loading the machine, please always ensure that there are no foreign bodies present in the pockets or in between the items to be washed. Paper clips, nails, etc. which may find their way into the washing machine along with the washing will remain in the drain pump housing (foreign body trap that protects the pump wheel).



**Warning!** Before opening the cover of the drain pump, switch off the washing machine and remove the power plug from the power point.

1. First carry out an emergency drain.
2. Place a cloth on the floor in front of the cover of the drain pump.  
Residual water runs out.
3. Unscrew the pump cover in an anti-clockwise direction and remove it.

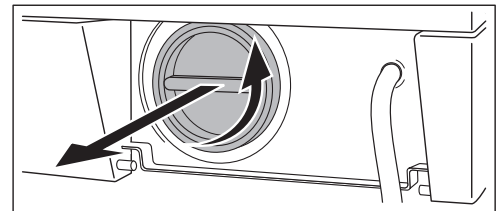

4. Remove foreign bodies and fluff from the pump housing and from the pump wheel.

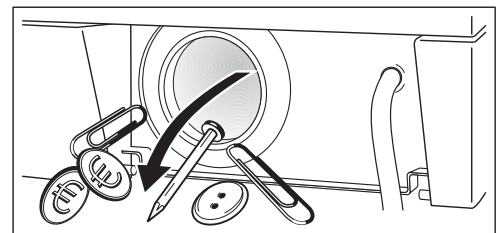

5. Check whether the pump wheel right at the back of the pump housing can turn. (If the wheel rotates with a jerky motion, this is normal.) If the pumping wheel cannot be turned, please contact your local Service Force Centre.

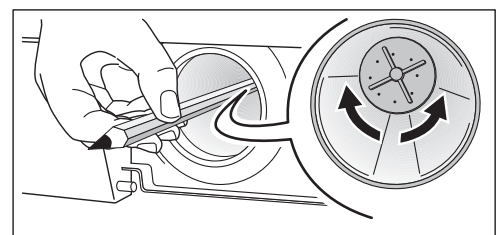

6. Insert the pump cover. Insert the guides at the sides of the cover into the guide slots and tighten the cover by turning in a clockwise direction.

7. Close off the emergency drain hose and place it in the retainer.

8. Close the plinth flap.

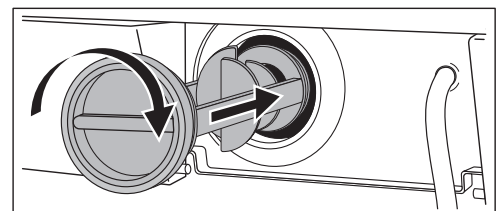

# Technical data

 This appliance conforms with the following EU Directives:

- 73/23/EEC dated 19.02.1973 Low Voltage Directive
- 89/336/EEC dated 03.05.1989 EMC Directive inclusive of Amending Directive 92/31/EEC
- 93/68/EEC dated 22.07.1993 CE Marking Directive

Height x Width x Depth	850 x 598 x 630mm
Depth when door is open	1010mm
Height adjustability	about +10/-5mm
Load (depending on programme)	max. 5kg
Area of use	Domestic
Drum spin speed	see rating plate
Water pressure	1-10bar (=10-100N/cm <sup>2</sup> =0.1-1.0MPa)

## Consumption values

The consumption values were obtained under standardised conditions. They may vary when operating in domestic conditions.

Programme/Temperature	Load size in kg <sup>1)</sup>	Water in litres	Energy in kWh
COTTONS 95°	5	50	1,80
COTTONS ECONOMY 60° <sup>2)</sup>	5	35	0,85
COTTONS 40°	5	46	0,55
SYNTHETICS 40°	2,5	45	0,50
DELICATES 30°	2,5	52	0,35
WOOL  30°	2	44	0,28

1) The load size is determined in accordance with the EN 60456 standard load.

2) **Note:** This 60° programme is the programme setting for testing in accordance with or in support of EN 60 456 and IEC 60 456. Consumption values will vary from the values quoted depending on water pressure, water hardness, water temperature at filling, room temperature, type and quantity of washing, detergent used, variations in mains voltage and any options selected.

# Installation and connection instructions

## Safety information concerning installation

- Before using for the first time, check the appliance for damage sustained while it was being transported. Do not under any circumstances connect an appliance that is damaged to the mains. In the event of damage to the appliance contact your supplier.
- Be sure to remove all the components of the transit packaging before using the appliance for the first time. Otherwise when spinning damage may be caused to the appliance or to neighbouring units or furniture.
- Before using the appliance for the first time, splash protection must be completed. (See “Removing transit packaging”).
- Always plug the mains plug into a correctly installed shockproof socket.
- If hard-wired: hard-wiring to the mains may only be carried out by an a qualified electrician.
- Prior to using the appliance for the first time, ensure that the rated voltage and current on the rating plate match the mains voltage and current where the appliance is to be installed. The required fuse protection is also to be found on the rating plate.
- If work on the plumbing is required for the proper connection of the washing machine to the water supply, this must be undertaken by a registered plumber.
- If work on the electricity supply system is required for the proper connection of the washing machine to the electricity supply, this must be undertaken by a registered electrician.
- The washing machine’s mains cable must only be replaced by a Service Force Engineer

## Installing the appliance

### Transporting the appliance



**Warning:** The washing machine is very heavy. There is a risk of injury. Exercise care when lifting the appliance.

- Do not lay the washing machine on its front nor on its right side (as seen from the front). Electrical components may get wet.
- Never transport the appliance without using the transit packaging. Only remove the transit packaging when the appliance is in its place of installation. Transporting the appliance without the use of the transit packaging can cause damage to the appliance.
- Never lift the appliance by the door when it is open nor by the plinth.

#### **When using a sack trolley to transport the washing machine:**

- Only use the sack trolley on the side of the appliance.

# Removing the transit pack-aging

**Important!** Be sure to remove all the components of the transit packaging prior to using the appliance for the first time. Keep the transit packaging in a safe place, in case it is needed at a later date when the appliance is to be moved (e.g. moving house).

1. Open the two hose retainers located at the rear of the appliance and remove the hoses and electrical cable.

2. Remove the two hose retainers from the appliance with a strong tug.

**i** Special spanner A and sealing caps B (2 units) and C (1 unit) come with the appliance.

3. Use special spanner A to remove screw D and the compression spring.

4. Turn sealing cap C upside down as shown in the illustration.

5. Use sealing cap C to cap the hole.

6. Use special spanner A to remove the two screws E.

7. Use special spanner A to remove the four screws F.

8. Remove transit bar G.

9. Screw in the four screws F again.

10. Use sealing caps B to cap the two large holes.

**Important:** Press all sealing caps B (2 items) and C (1 item) in firmly so that they snap into the rear wall.

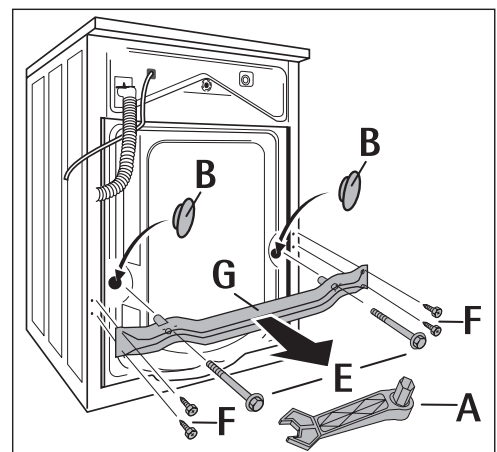
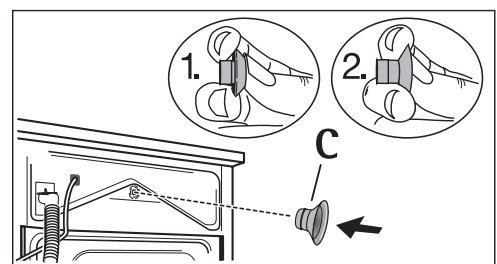
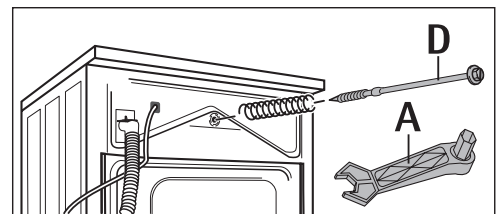
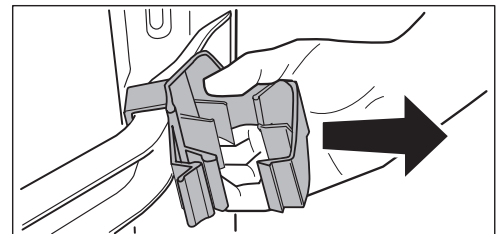
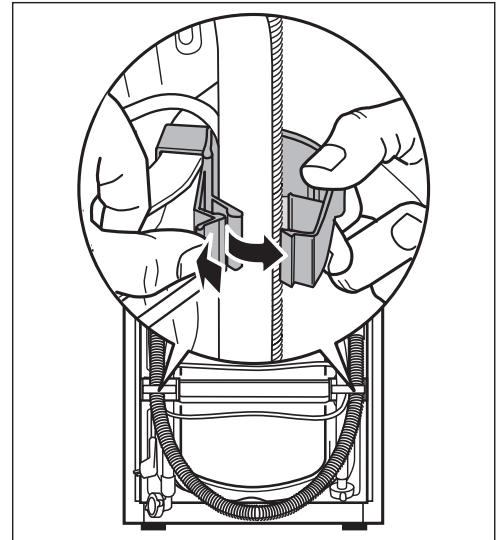

## Where to install

**Important!** The washing machine must not be operated in a room where there is a danger of frost. There is a risk of frost damage or adverse effect on the performance of the machine. Frost damage is not covered under the warranty.

- The surface on which the appliance is to be installed must be firm and level. Do not install the appliance on carpeted floors or soft floor coverings.
- The surface on which the appliance is to be installed must be clean and dry and free from grease, so that the appliance does not slide.
- If the location in which the appliance is to be installed is fitted with small-format tiles, put a rubber mat (available in the shops) under the appliance.

### If the appliance is to stand on a base:

In order for the appliance to be secure on the base, fixing plates\*) must be mounted, into which the appliance is inserted.

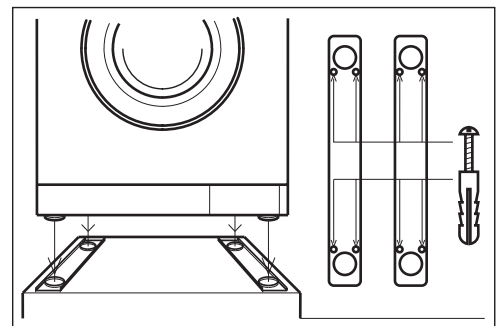

### If the appliance is to stand on a floor which moves, e.g. a suspended wooden floor:

Place the appliance in an area as close as possible to a corner of the room.

Screw a water-resistant wooden board (at least 15 mm thick) onto at least 2 of the floor joists.

## Making the appliance level

The four feet of the appliance are pre-adjusted. Large degrees of unevenness can be compensated for by individually adjusting the height adjustable screw feet.

Use the special spanner supplied to do this.

**Important!** Do not use pieces of wood, cardboard or such like to level out unevenness in the floor, but adjust the height adjustable screw feet instead.

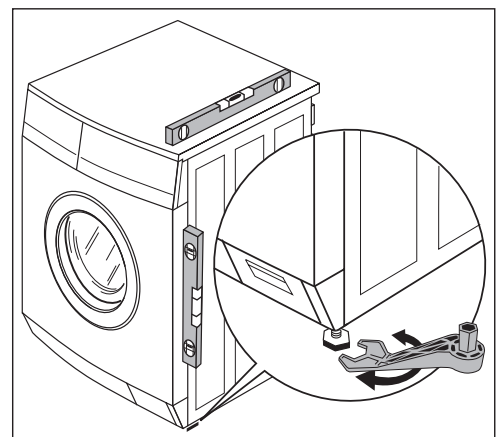

# Electrical Connection

Any electrical work required to install this appliance should be carried out by a qualified electrician or competent person.



## **WARNING – THIS APPLIANCE MUST BE EARTHED.**

The manufacturer declines any liability should these safety measures not be observed.

Before switching on, make sure the electricity supply voltage is the same as that indicated on the appliance rating plate.

The appliance is supplied with a 13 amp plug fitted. In the event of having to change the fuse in the plug supplied, a 13 amp ASTA approved (BS 1362) fuse must be used.

Should the plug need to be replaced for any reason, proceed as described below.

The wires in the mains lead are coloured in accordance with the following code:

Green and Yellow:	Earth
Blue:	Neutral
Brown:	Live

- The wire coloured green and yellow must be connected to the terminal marked with the letter “E” or by the earth symbol  $\oplus$  or coloured green and yellow.
- The wire coloured blue must be connected to the terminal “N” or coloured black.
- The wire coloured brown must be connected to the terminal marked “L” or coloured red.
- Upon completion there must be no cut, or stray strands of wire present and the cord clamp must be secure over the outer sheath.



**WARNING!** A cut off plug inserted into a 13 amp socket is a serious safety (shock) hazard. Ensure that the cut off plug is disposed of safely.

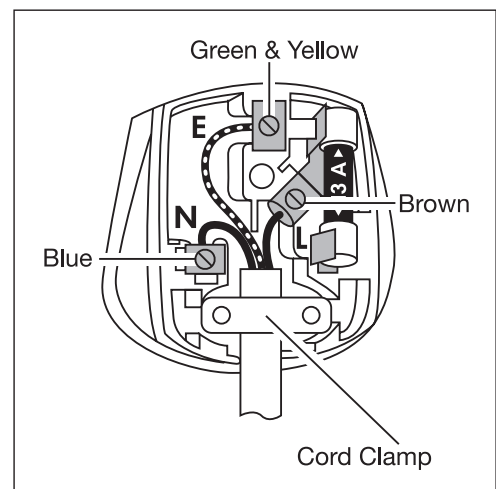

## Permanent Connection

In the case of a permanent connection it is necessary that you install a double pole switch between the appliance and the electricity supply (mains), with a minimum gap of 3mm between the switch contacts and of a type suitable for the required load in compliance with the current electrical regulations.

The switch must not break the yellow and green earth cable at any point.

This appliance complies with the requirements laid out in the EEC Directive 76/899.

Voltage 240 V AC: Fuse rating 13amps

See rating plate for further information.

This appliance meets VDE requirements.

Particular regulations of local electricity authorities must be observed.

This appliance conforms to EEC Directive No. 82/499/EWG on radio interference.



**WARNING!** Repairs to electrical appliances must only be carried out by trained personnel. Improper repairs may lead to serious risks for the user.

# Connecting the appliance to the water supply

### Important:

- This appliance must **not** be connected to the hot water supply.
- When connecting the appliance, use only new hose kits.
- Only connect the appliance to the drinking water supply. Rain water or water for industrial use may only be used if it fulfils the requirements of DIN 1986 and DIN 1988.
- Do not kink or crush the water inlet hose or drain hose.

### Permitted water pressure

The water pressure must be at least 1 bar ( $=10\text{N}/\text{cm}^2=0.1\text{MPa}$ ), and may be a maximum of 10bar ( $=100\text{N}/\text{cm}^2 =1\text{MPa}$ ).

- If more than 10bar: Connect a pressure reduction valve.
- If less than 1 bar: Disconnect the appliance end of the inlet hose from the solenoid inlet valve and remove the flow meter. (In addition remove the filter using pointed pliers and take out the rubber gasket behind it.) Replace the filter.



## Water inlet

A 1.35m long pressure hose is supplied with the appliance.

If a longer inlet hose is required, only hoses from the manufacturer are to be used. Your local Service Force stocks hose kits of different lengths.

**i** Sealing rings are either inserted in the plastic nuts of the threaded hose fitting or are included as spare parts. Do not use any other sealing rings.

**Important!** All threaded hose fittings must only be tightened by hand.

1. Connect the hose with the right-angle connector to the machine.

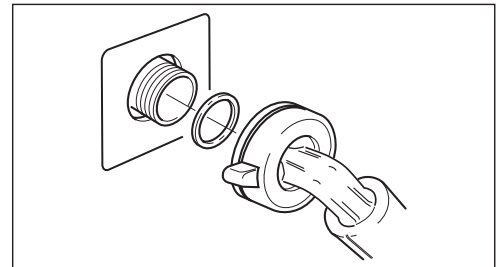

**Important!** Do not position the inlet hose vertically downwards. Position it to the right or the left as shown in the illustration.

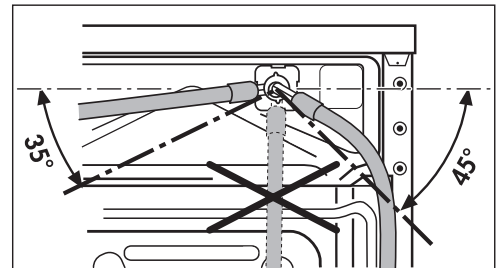

2. Connect the hose with the straight connector to a water tap with an R  $\frac{3}{4}$  (inch) screw thread.

3. Slowly turn on the tap and check that all connections are watertight.

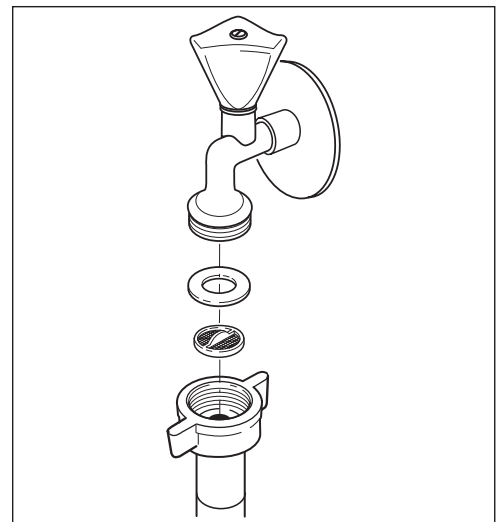

# Water Drainage

The appliance drain hose should hook into a standpipe, the hook in the drain hose is formed using the plastic “U-Piece” supplied. The standpipe should have an internal diameter of approximately 38 mm (see diagram) thus ensuring there is an air break between the drain hose and standpipe.

**Important!** It is essential to lay the drainage hose without kinks.

When discharging into a standpipe ensure that the top of the curve in the hose end is no more than 90 cm (35.4”) and no less than 60 cm (23.6”) above floor level.

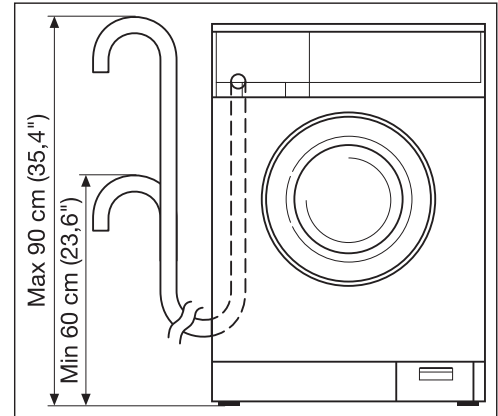

The upright standpipe should have a minimum length of 30 cm (12”) from the bottom of the elbow to the top of the pipe (see diagram). Make sure that it is designed in such a way that the end of the drain hose cannot be covered with water.

Longer drain hoses are available in lengths of 2.7 and 4 metres from your Service Force Centre.

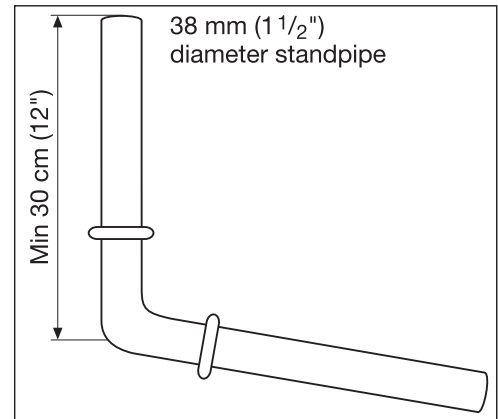

## For drainage into an outlet

**spigot:** If the outlet spigot has not been used before, remove any blanking plug that may be in place. Push the drain hose onto the spigot and secure with a clip if required. Ensure the drain hose is looped upwards to prevent waste water from the sink entering the washing machine.

**Important!** The end of the drainage hose must not be submerged in the pumped-out water. Otherwise, the water could be sucked back into the appliance.

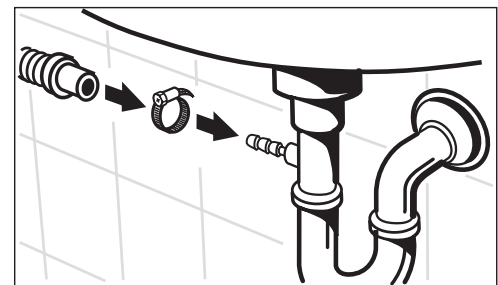

## Pumping heights of over 1 metre

The washing machine’s drain pump is able to pump water to a height of 1 metre, calculated from the surface on which the appliance is installed.

**Important!** If pumping height is over 1 metre malfunctions and damage to the appliance may arise.

For pumping heights over 1 metre a conversion kit can be obtained. Please contact Service Force Centre.

# Fitting under kitchen worktops

**Important:** The water supply tap and power outlet must remain accessible after the appliance is installed.

## Permanent connection

In the case of a permanent connection it is necessary that you install a double pole switch between the appliance and the electricity supply (mains), with a minimum gap of 3 mm between the switch contacts and of a type suitable for the required load in compliance with the current electrical regulations. The switch must not break the yellow and green earth cable at any point.

This operation should only be performed by a qualified electrician.

## Kitchen with worktops 85 cm high.

The washing machine can be installed in **fully fitted kitchens** with continuous worktops 85 cm high, after removing the machine's top cover. This will reduce the height of the appliance to about 82 cm.

To fit the washing machine, an adapter kit is required. These can be obtained from Customer Service.



**Warning!** If removing the top cover to fit the machine,

- another protective cover must be mounted and, the appliance must be earthed with special screws
- a replacement trim must be attached to the top front edge.

Then only should the appliance be connected electrically, and put into operation. The protective cover, special screws and replacement trim are included in adapter kit.

## Recess size requirements

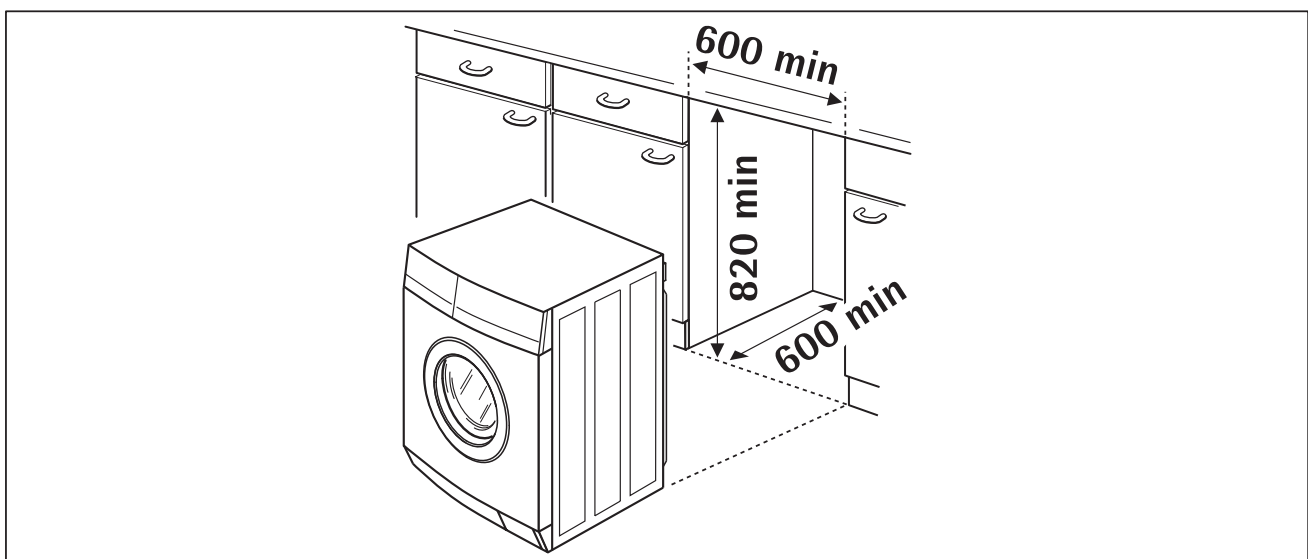

(Measurements in mm)

## Kitchens with worktops 90 cm or higher



**Warning!** If fitting under a worktop of 90 cm or higher, the top cover must be left on the appliance, to protect it from splashes. Otherwise, adequate protection cannot be guaranteed.

In fitted kitchens with worktops 90 cm or higher, insert the appliance in its niche leaving the top cover in place.

# Warranty conditions

## Standard guarantee conditions

We, Zanussi Electrolux, undertake that if, within 12 months of the date of the purchase, this ZANUSSI ELECTROLUX appliance or any part thereof is proved to be defective by reason only of faulty workmanship or materials, we will, at our option repair or replace the same FREE OF ANY CHARGE for labour, materials or carriage on condition that:

- The appliance has been correctly installed and used only on the electricity supply stated on the rating plate.
- The appliance has been used for normal domestic purposes only, and in accordance with the manufacturer's instructions.
- The appliance has not been serviced, maintained, repaired, taken apart or tampered with, by any person not authorised by us.
- All service work under this guarantee must be undertaken by a Service Force Centre.
- Any appliance or defective part replaced shall become the Company's property.
- This guarantee is in addition to your statutory and other legal rights.

Home visits are made between **8.30am** and **5.30pm** Monday to Friday. Visits may be available outside these hours in which case a **premium** will be charged.

## Exclusions

### This guarantee does not cover:

- Damage or calls resulting from transportation, improper use or neglect, the replacement of any light bulbs or removable parts of glass or plastic.
- Costs incurred for calls to put right an appliance which is improperly installed or calls to appliances outside the United Kingdom.
- Appliances found to be in use within a commercial environment, plus those which are subject to rental agreements.
- Products of Zanussi Electrolux manufacture which are NOT marketed by Zanussi Electrolux.

## European guarantee

If you should move to another country within Europe then your guarantee moves with you to your new home subject to the following qualifications:

- The guarantee starts from the date you first purchased your product.
- The guarantee is for the same period and to the same extent for labour and parts as exists in the new country of use for this brand or range of products.
- The guarantee relates to you and cannot be transferred to another user.
- Your new home is within the European Community (EC) or European Free Trade Area.
- The product is installed and used in accordance with our instructions and is only used domestically, i.e. a normal household.
- The product is installed taking into account regulations in your new country.

Before you move please contact your nearest Customer Care Centre, listed below, to give them details of your new home. They will then ensure that the local Service Organisation is aware of your move and able to look after you and your appliances.

France	Senlis	+33 (0) 344 62 29 29
Germany	Nürnberg	+49 (0) 800 234 7378
Italy	Pordernone	+39 0434 39 4700
Sweden	Stockholm	+46 (0) 8 672 53 90
UK	Slough	+44 (0) 1753 219897
Ireland	Dublin	+44 (0)1 4090751



# Service and Spare Parts

If the event of your appliance requiring service, or if you wish to purchase spare parts, please contact Service Force by telephoning:

**0870 5 929 929**

Your telephone call will be automatically routed to the Service Force Centre covering your post code area.

For the address of your local Service Force Centre and further information about Service Force, please visit the website at

**[www.serviceforce.co.uk](http://www.serviceforce.co.uk)**

Before calling out an engineer, please ensure you have read the details under the heading „What to do if...“

When you contact the Service Force Centre you will need to give the following details:

1. Your name, address and post code.
2. Your telephone number.
3. Clear and concise details of the fault.
4. The model and serial number of the appliance (found on the rating plate)
5. The purchase date.

Please note that a valid purchase receipt or guarantee documentation is required for in-guarantee service calls.

## **Customer Care Department**

For general enquiries concerning your Zanussi Electrolux appliance, or for further information on Zanussi Electrolux products, please contact our Customer Care Department by letter or telephone at the address below or visit our website at [www.zanussi.co.uk](http://www.zanussi.co.uk).

Customer Care Department  
Zanussi Electrolux  
55-77 High Street  
Slough  
Berkshire, SL1 1DZ  
Tel: 08705 727727 (\*)

(\*) calls to this number may be recorded for training purposes.

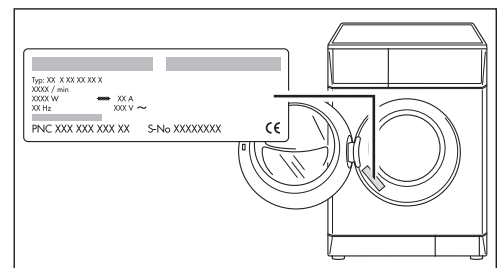

# ZANUSSI

 **Electrolux**

105 176 054-00-150205-04

Subject to change without notice

 **The Electrolux Group. The world's No. 1 choice.**

*The Electrolux Group is the world's largest producer of powered appliances for kitchen, cleaning and outdoor use. More than 55 million Electrolux Group products (such as refrigerators, cookers, washing machines, vacuum cleaners, chain saws and lawn mowers) are sold each year to a value of approx. USD 14 billion in more than 150 countries around the world.*